

# LOCK-BLOCK LTD.

Manufacturers of the LOCK-BLOCK™ Retaining wall system

13171 Mitchell Road, Richmond, B.C. V6V 1M7

Toll free 1-800-565-2565 Fax. (604)325-3124

Website: [www.LockBlock.com](http://www.LockBlock.com) E-mail: [lock-block@telus.net](mailto:lock-block@telus.net)

## Page 1 - Keyed

<p>750 mm 750 mm 1500 mm</p> <p>Standard</p>	<p>750 mm 750 mm 750 mm</p> <p>Half</p>	<p>750 mm 1500 mm 1500 mm</p> <p>Double Wide</p>
<p>375 mm 750 mm 1500 mm</p> <p>Half-Height</p>	<p>375 mm 750 mm 750 mm</p> <p>Half-Height Half</p>	<p>1500 mm 750 mm 750 mm</p> <p>Gutter</p>
<p>750 mm 750 mm 2250 mm</p> <p>Three Cross</p>	<p>750 mm 750 mm 3000 mm</p> <p>Four Cross</p>	<p>750 mm 750 mm 3750 mm</p> <p>Five Cross</p>
<p>375 mm 750 mm 1500 mm</p> <p>Half-Height Three Cross</p>	<p>22.5 degrees 750 mm 1500 mm 153 mm</p> <p>Wedge</p>	<p>750 mm 750 mm 1500 mm</p> <p>Chamferless</p> <p>Chamferless versions of Standard, Half, Flat Top and Half Flat are available for \$10 more</p>

Blocks are normally available for immediate delivery, however some configurations may not be in stock and will therefore require advance notice. Granite facing or textured facing can be added to most blocks upon request

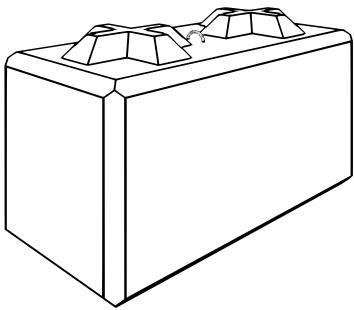

# LOCK-BLOCK LTD.

Manufacturers of the LOCK-BLOCK™ Retaining wall system

13171 Mitchell Road, Richmond, B.C. V6V 1M7

Toll free 1-800-565-2565 Fax. (604)325-3124

Website: [www.LockBlock.com](http://www.LockBlock.com) E-mail: [lock-block@telus.net](mailto:lock-block@telus.net)

## Page 2 - Flat Top / Transition

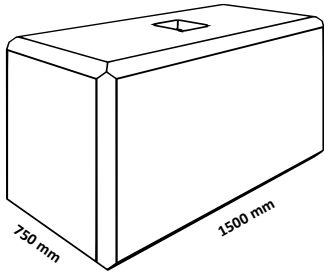

Flat Top

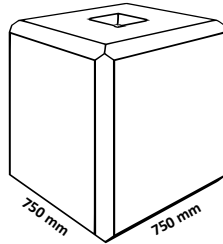

Half Flat Top

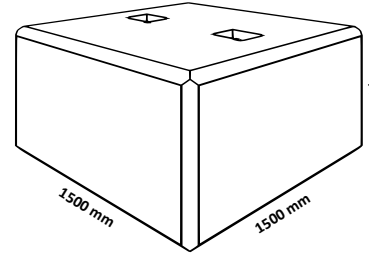

Double Wide Flat Top

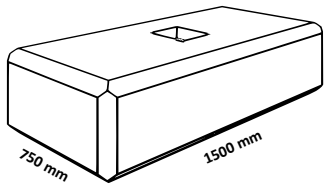

Half-Height Flat Top

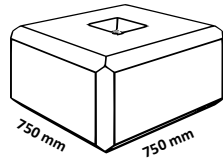

Half-Height Half Flat Top

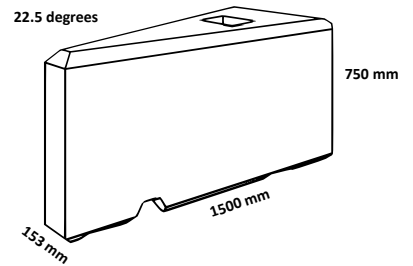

Wedge Flat Top

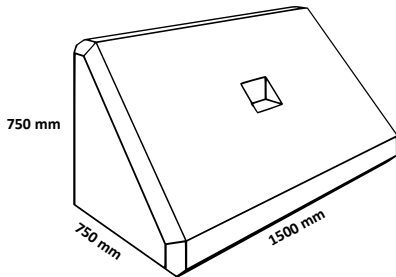

Side Transition

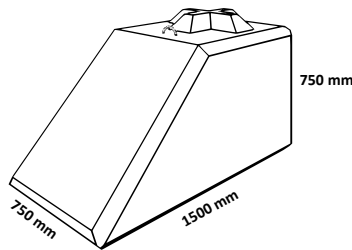

Transition

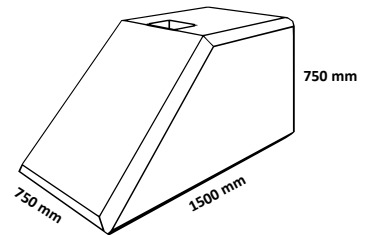

Transition Flat Top

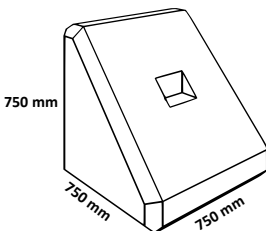

Half Transition

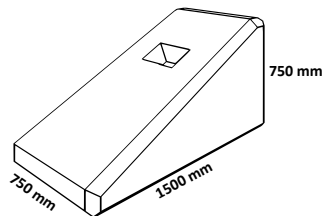

2 to 1 Transition

Blocks are normally available for immediate delivery, however some configurations may not be in stock and will therefore require advance notice. Granite facing or textured facing can be added to most blocks upon request

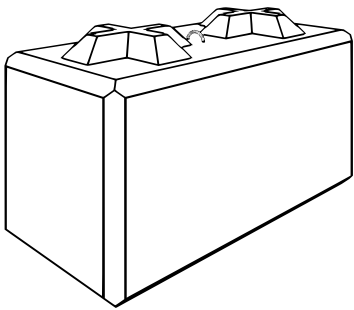

# LOCK-BLOCK LTD.

Manufacturers of the LOCK-BLOCK™ Retaining wall system

13171 Mitchell Road, Richmond, B.C. V6V 1M7

Toll free 1-800-565-2565 Fax. (604)325-3124

Website: [www.LockBlock.com](http://www.LockBlock.com) E-mail: [lock-block@telus.net](mailto:lock-block@telus.net)

## Page 3 - Benches

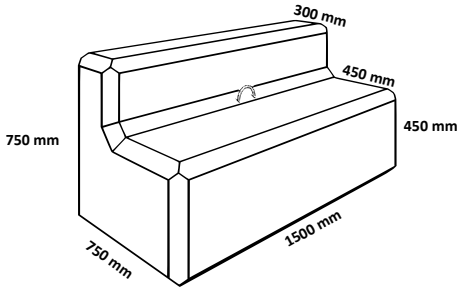

Bench

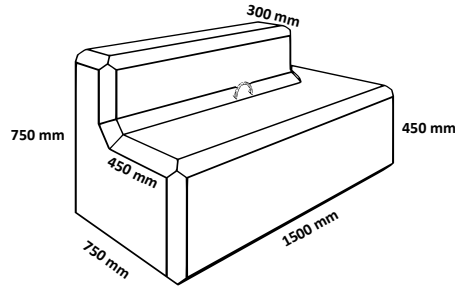

Left Inside Corner Bench

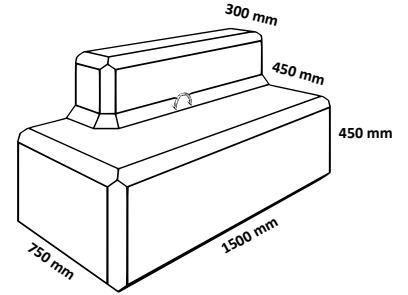

Right Inside Corner Bench

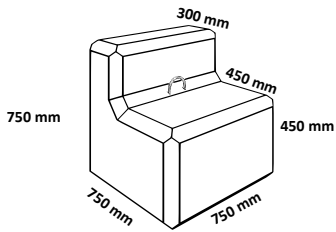

Half Bench

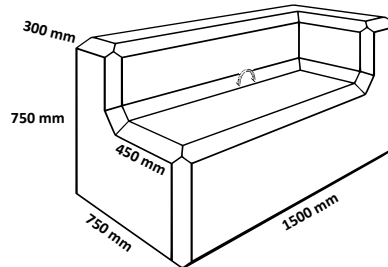

Left Corner Bench

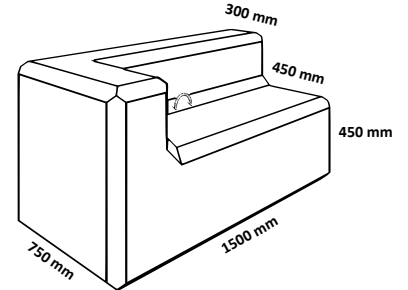

Right Corner Bench

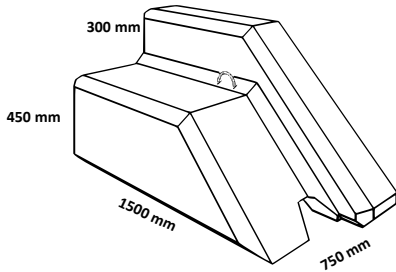

Left Beach Transition

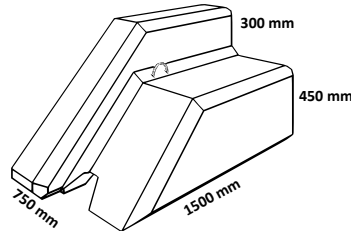

Right Beach Transition

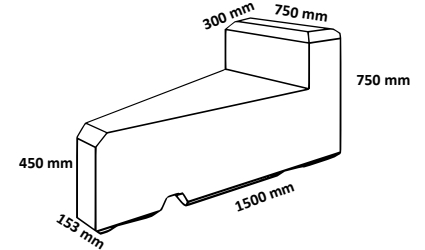

Wedge Bench

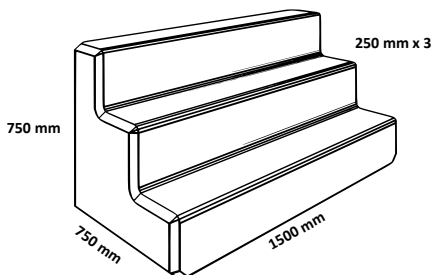

Full Stairs

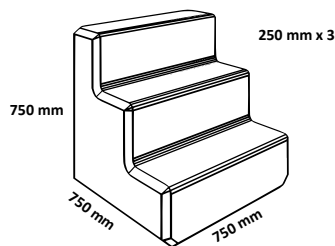

Half Stairs

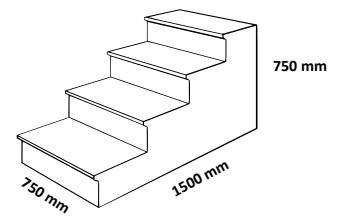

4 Step Stairs

Blocks are normally available for immediate delivery, however some configurations may not be in stock and will therefore require advance notice. Granite facing or textured facing can be added to most blocks upon request

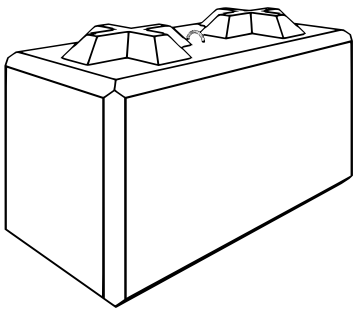

# LOCK-BLOCK LTD.

Manufacturers of the LOCK-BLOCK™ Retaining wall system

13171 Mitchell Road, Richmond, B.C. V6V 1M7

Toll free 1-800-565-2565 Fax. (604)325-3124

Website: [www.LockBlock.com](http://www.LockBlock.com) E-mail: [lock-block@telus.net](mailto:lock-block@telus.net)

## Page 4 - Specialty

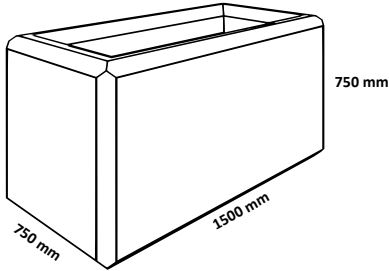

Planter

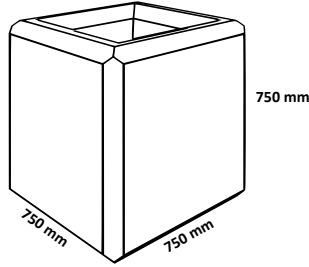

Half Planter

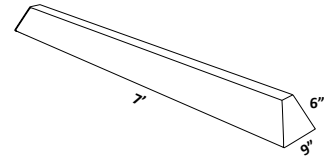

Parking Curb

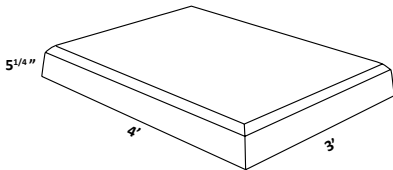

4' x 3' Parking Pad

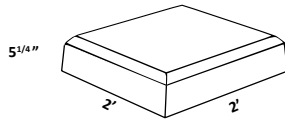

2' x 2' Parking Pad

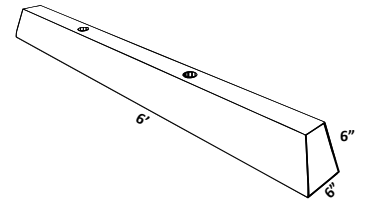

Tuf-Stop™ Curb by Tuf-Tite

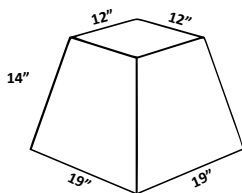

Truncated Pyramid

Blocks are normally available for immediate delivery, however some configurations may not be in stock and will therefore require advance notice. Granite facing or textured facing can be added to most blocks upon request

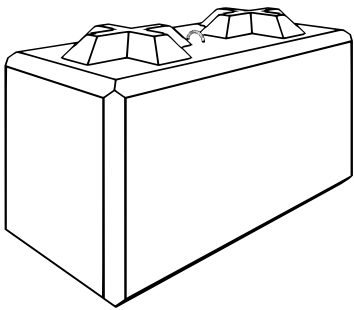

# LOCK-BLOCK LTD.

Manufacturers of the LOCK-BLOCK™ Retaining wall system

13171 Mitchell Road, Richmond, B.C. V6V 1M7

Toll free 1-800-565-2565 Fax. (604)325-3124

Website: [www.LockBlock.com](http://www.LockBlock.com) E-mail: [lock-block@telus.net](mailto:lock-block@telus.net)

## Page 5 - Barriers pt 1

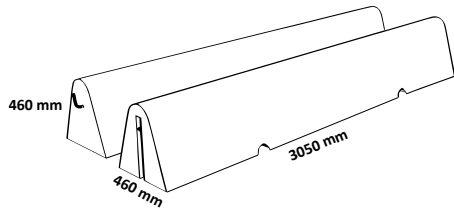

460 mm CLB

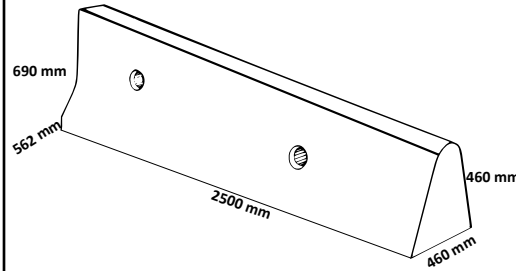

460 mm to 690 mm Transition

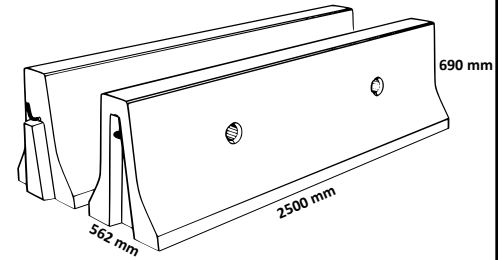

690 mm CRB

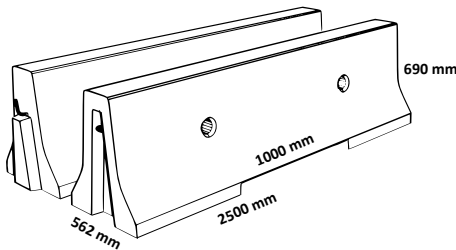

690 mm CRB Scupper

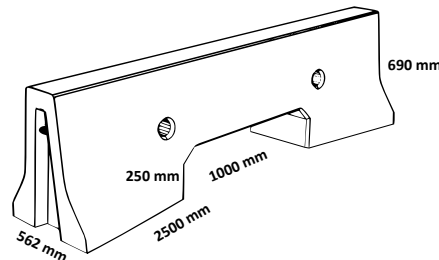

690 mm CDB Drainage

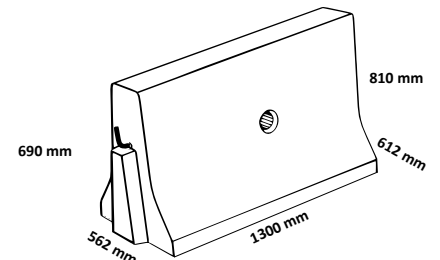

690 mm to 810 mm Transition

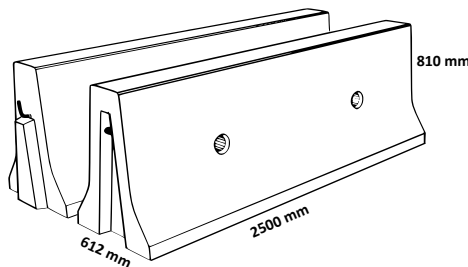

810 mm CMB

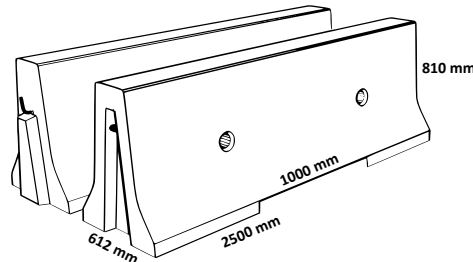

810 mm CMB Scupper

Barriers are made as either Female-Female (E) as depicted in front or Male-Male (H) as depicted behind.

All barriers can be made with steel reinforcement instead of fibre by request.

Blocks are normally available for immediate delivery, however some configurations may not be in stock and will therefore require advance notice. Granite facing or textured facing can be added to most blocks upon request

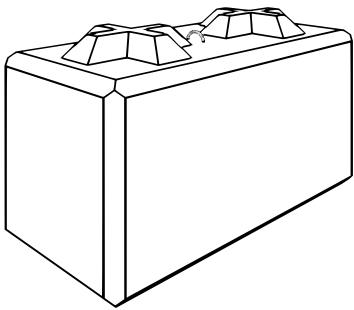

# LOCK-BLOCK LTD.

Manufacturers of the LOCK-BLOCK™ Retaining wall system

13171 Mitchell Road, Richmond, B.C. V6V 1M7

Toll free 1-800-565-2565 Fax. (604)325-3124

Website: [www.LockBlock.com](http://www.LockBlock.com) E-mail: [lock-block@telus.net](mailto:lock-block@telus.net)

## Page 6 - Barriers pt 2

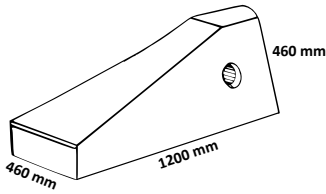

460 CBN Bullnose

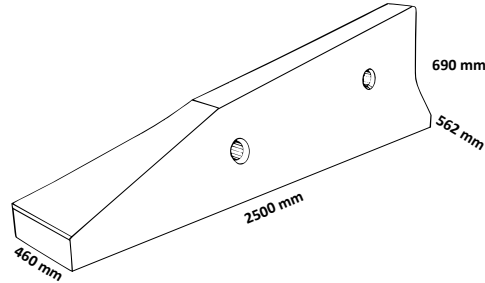

690 mm Bullnition

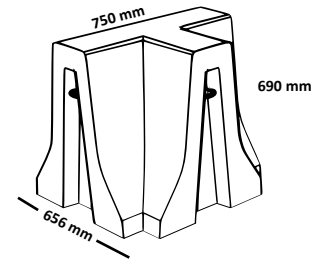

690 mm T Junction

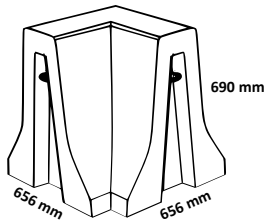

690 mm L Junction

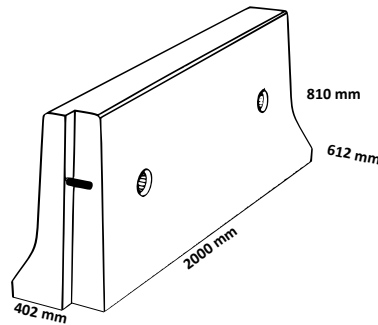

810 Bridge Parapet Transition

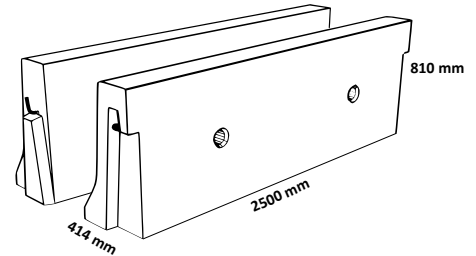

810 CPB Pier Barrier

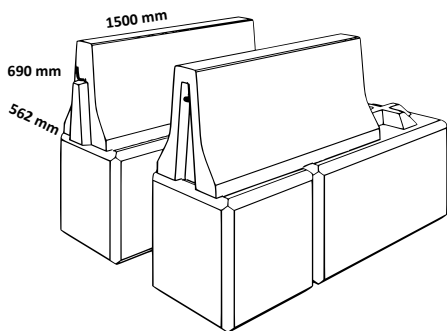

690 mm Lock-Block™ Barrier

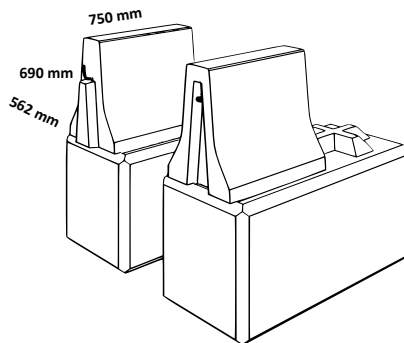

690 mm Lock-Block™ Barrier Half

Blocks are normally available for immediate delivery, however some configurations may not be in stock and will therefore require advance notice. Granite facing or textured facing can be added to most blocks upon request

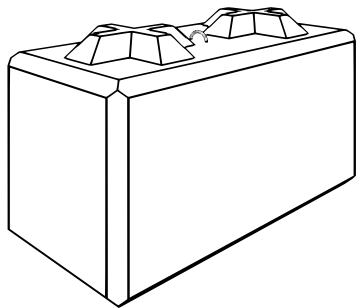

# LOCK-BLOCK LTD.

Manufacturers of the LOCK-BLOCK™ Retaining wall system

13171 Mitchell Road, Richmond, B.C. V6V 1M7

Toll free 1-800-565-2565 Fax. (604)325-3124

Website: [www.LockBlock.com](http://www.LockBlock.com) E-mail: [lock-block@telus.net](mailto:lock-block@telus.net)

## Page 7 - Mini Blocks pt 1

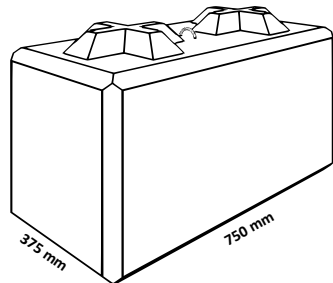

Standard Mini

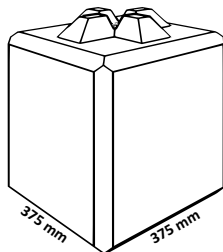

Half Mini

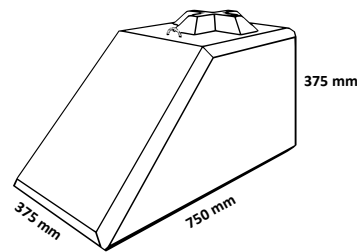

Transition Mini

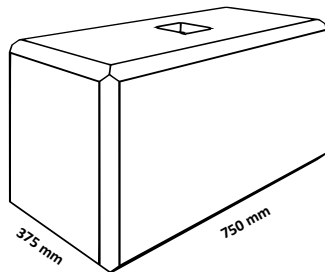

Flat Top Mini

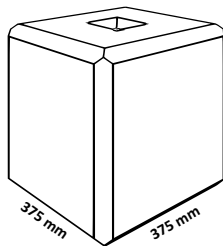

Half Flat Top Mini

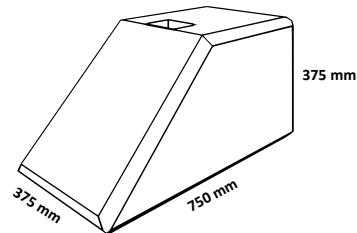

Transition Flat Top Mini

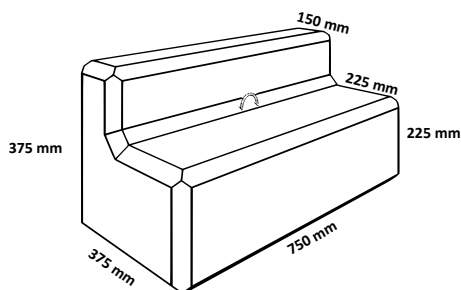

Bench Mini

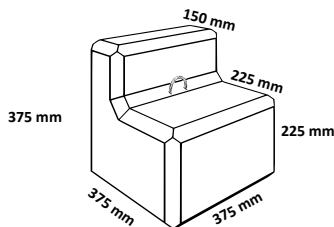

Half Bench Mini

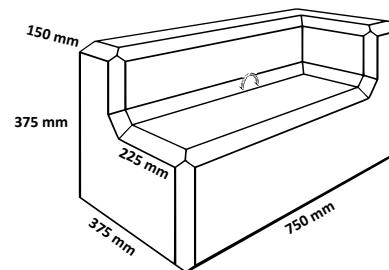

Left Corner Bench Mini

Blocks are normally available for immediate delivery, however some configurations may not be in stock and will therefore require advance notice. Granite facing or textured facing can be added to most blocks upon request

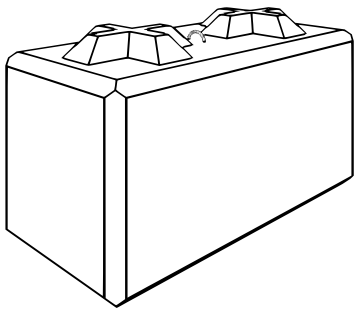

# LOCK-BLOCK LTD.

Manufacturers of the LOCK-BLOCK™ Retaining wall system

13171 Mitchell Road, Richmond, B.C. V6V 1M7

Toll free 1-800-565-2565 Fax. (604)325-3124

Website: [www.LockBlock.com](http://www.LockBlock.com) E-mail: [lock-block@telus.net](mailto:lock-block@telus.net)

## Page 8 - Mini Blocks pt 2

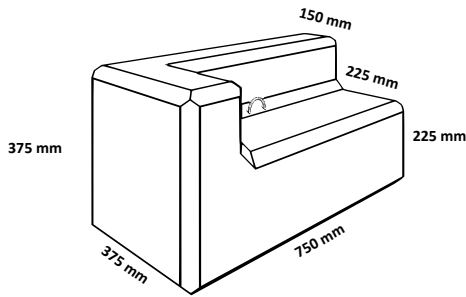

Right Corner Bench Mini

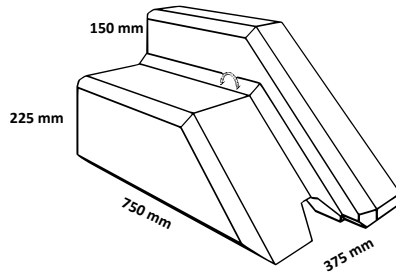

Left Beach Transition Mini

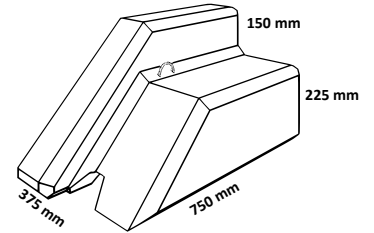

Right Beach Transition Mini

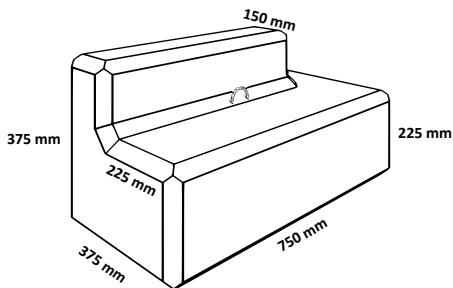

Left Inside Corner Bench Mini

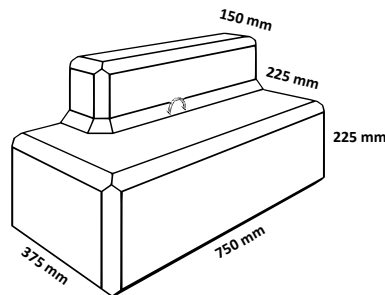

Right Inside Corner Bench Mini

Blocks are normally available for immediate delivery, however some configurations may not be in stock and will therefore require advance notice. Granite facing or textured facing can be added to most blocks upon request